

Hydrotech® Hydrodrain® StripDrain

formerly known as Hydrodrain® StripDrain



BUILDING TRUST



GENERAL DESCRIPTION

Hydrodrain StripDrain is a modular composite drainage and collection system consisting of a 3-dimensional, high-flow, drainage core, available in 6 and 12 inch widths, which is wrapped with a non-woven filter fabric. Soil particles are held back by the filter fabric allowing water to pass through to the drain core for easy removal to subsurface collection. StripDrain is combined with a full array of fittings to allow for a fast and easy installation. Hydrodrain SD-Tape is used to attach all Hydrodrain StripDrain fittings – End Caps, End Outlets, Side Outlets, Corners, Splices, and Step Downs. Hydrodrain StripDrain sections and fittings can be bonded to the waterproofed wall with an appropriate means or held in place with soil backfill.

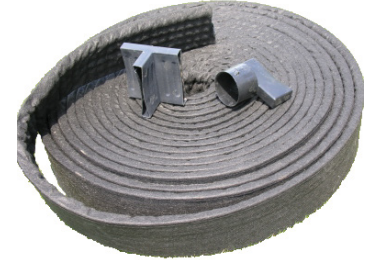

BASIC USE

Hydrodrain StripDrain is designed to replace a conventional sand or gravel covered pipe drain around building foundations and retaining walls. Hydrodrain StripDrain is installed along the base of a foundation wall and may be combined with Hydrodrain 400 or 420 for a complete foundation wall drainage assembly. Hydrodrain must be covered with subsequent overburden within 10-14 days of installation.

ADVANTAGES

- Eliminates pipe & gravel
- Lightweight and easy to install
- Saves time and labor – cost effective

SIZES

The Hydrodrain StripDrain is available in roll form, 6 or 12 inches wide/tall by 165 feet long, weighing 38 or 68 pounds respectively.

TECHNICAL DATA

| PROPERTY | TEST METHOD | GEOTEXTILE | RESULTS |
|----------------------------------|-------------|-----------------------------|----------------------------|
| THICKNESS | ASTM D1777 | -- | 1.0 in. |
| COMPRESSIVE STRENGTH | ASTM D1621 | -- | 9,500 psf |
| FLOW Hydraulic Gradient = 0.1 | ASTM D4716 | -- | 30 gal. / min. / ft. width |
| FLOW | ASTM D4491 | 140 gal. / min. / ft. width | -- |
| CBR PUNCTURE | ASTM D6241 | 250 lb. | -- |
| GRAB TENSILE | ASTM D4632 | 100 lb. | -- |
| APPARENT OPENING SIZE | ASTM D4751 | 70 U.S. Sieve | -- |

FOUNDATION WALL

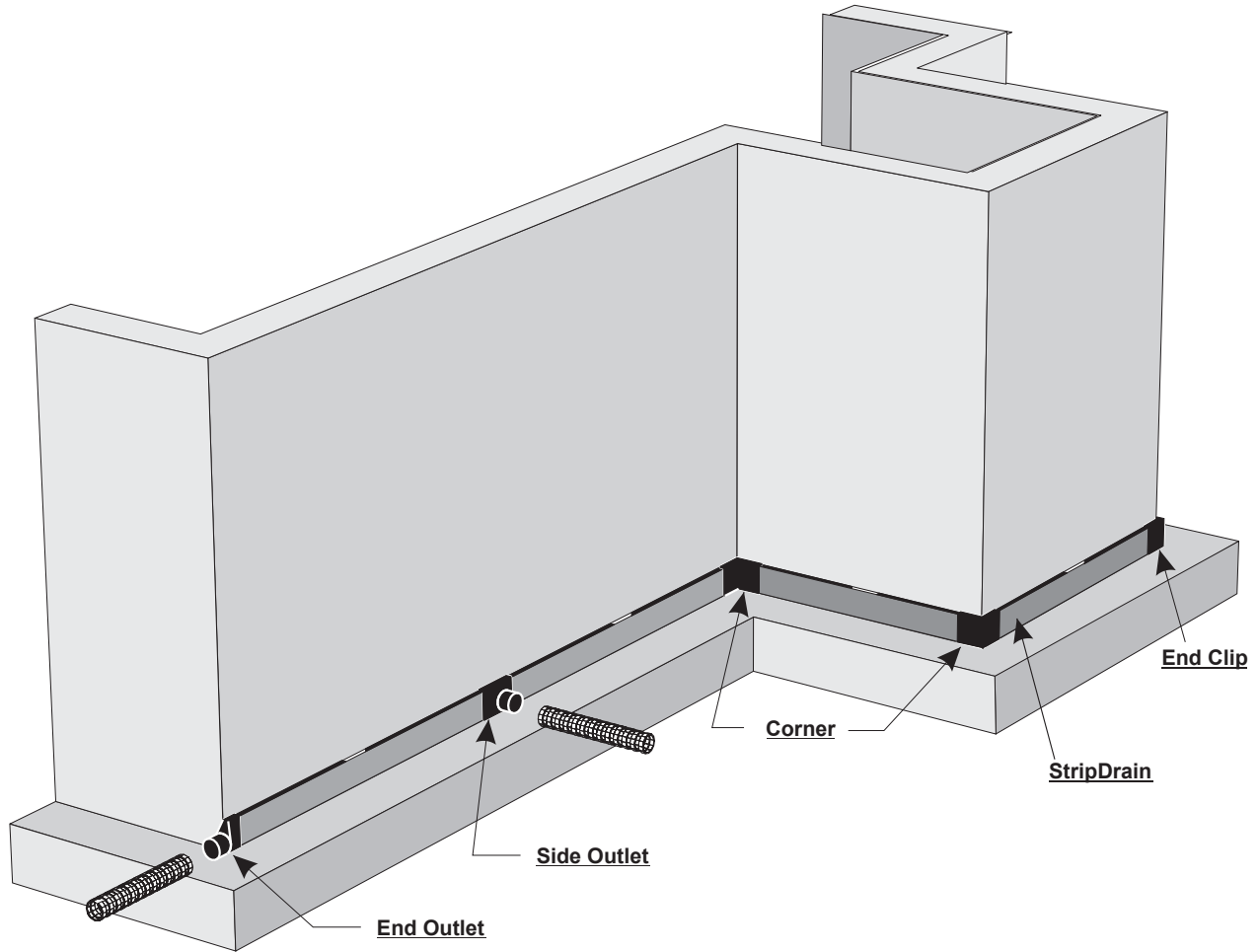

ACCESSORIES

END OUTLET

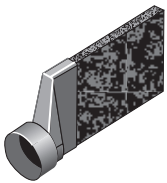

END CAP

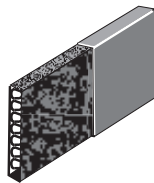

SIDE OUTLET

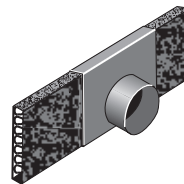

SPLICE

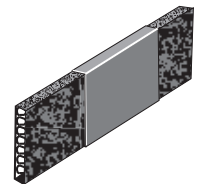

CORNER

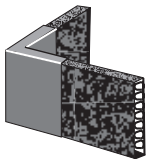

STEP DOWN

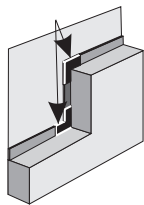

SD-TAPE



Prior to each use of any product of Sika Corporation, its subsidiaries or affiliates ("SIKA"), the user must always read and follow the warnings and instructions on the product's most current product label, Product Data Sheet and Safety Data Sheet which are available at usa.sika.com or by calling SIKA's Technical Service Department at 1-800-933-7452. Nothing contained in any SIKA literature or materials relieves the user of the obligation to read and follow the warnings and instructions for each SIKA product as set forth in the current product label, Product Data Sheet and Safety Data Sheet prior to use of the SIKA product.

SIKA warrants this product for one year from date of installation to be free from manufacturing defects and to meet the technical properties on the current Product Data Sheet if used as directed within the product's shelf life. User determines suitability of product for intended use and assumes all risks. User's and/or buyer's sole remedy shall be limited to the purchase price or replacement of this product exclusive of any labor costs. **NO OTHER WARRANTIES EXPRESS OR IMPLIED SHALL APPLY INCLUDING ANY WARRANTY OF MERCHANTABILITY OR FITNESS FOR A PARTICULAR PURPOSE. SIKA SHALL NOT BE LIABLE UNDER ANY LEGAL THEORY FOR SPECIAL OR CONSEQUENTIAL DAMAGES. SIKA SHALL NOT BE RESPONSIBLE FOR THE USE OF THIS PRODUCT IN A MANNER TO INFRINGE ON ANY PATENT OR ANY OTHER INTELLECTUAL PROPERTY RIGHTS HELD BY OTHERS.**

Sale of SIKA products are subject to the Terms and Conditions of Sale which are available at <https://usa.sika.com/en/group/SikaCorp/termsandconditions.html> or by calling 1-800-933-7452.